

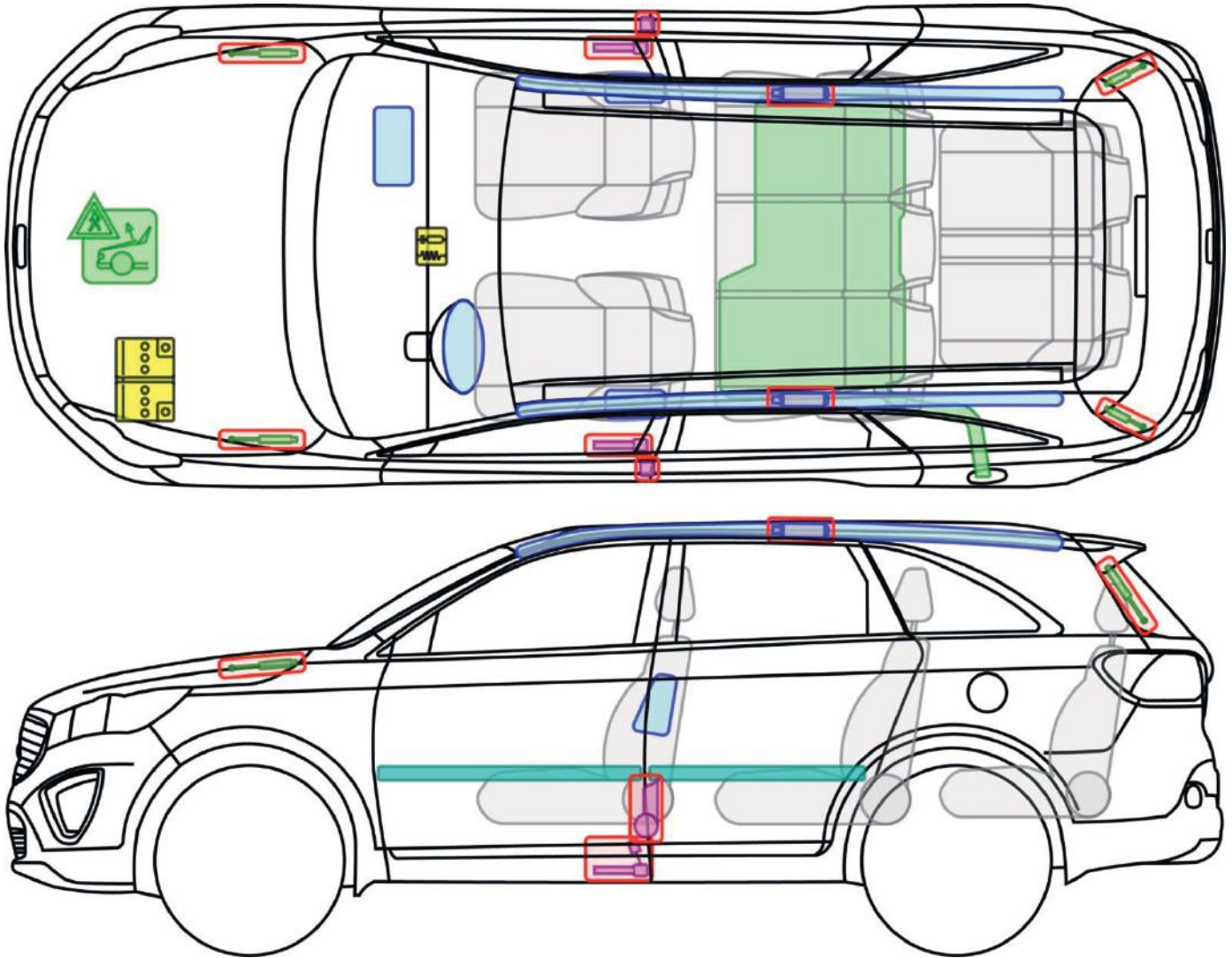

Sorento (UM)

ab 2014



Legende

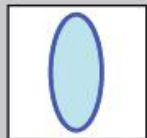

Airbag



Karosserie-
verstärkung



Steuergerät



Fußgänger-
schutz-
system

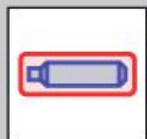

Gas-
generator



Überroll-
schutz

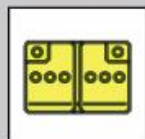

Batterie

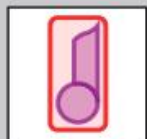

Gurt-
straffer

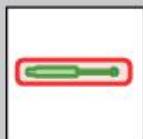

Gasdruck-
dämpfer



Kraftstoff-
tank

Sorento



Sorento (XM)

2009-2014

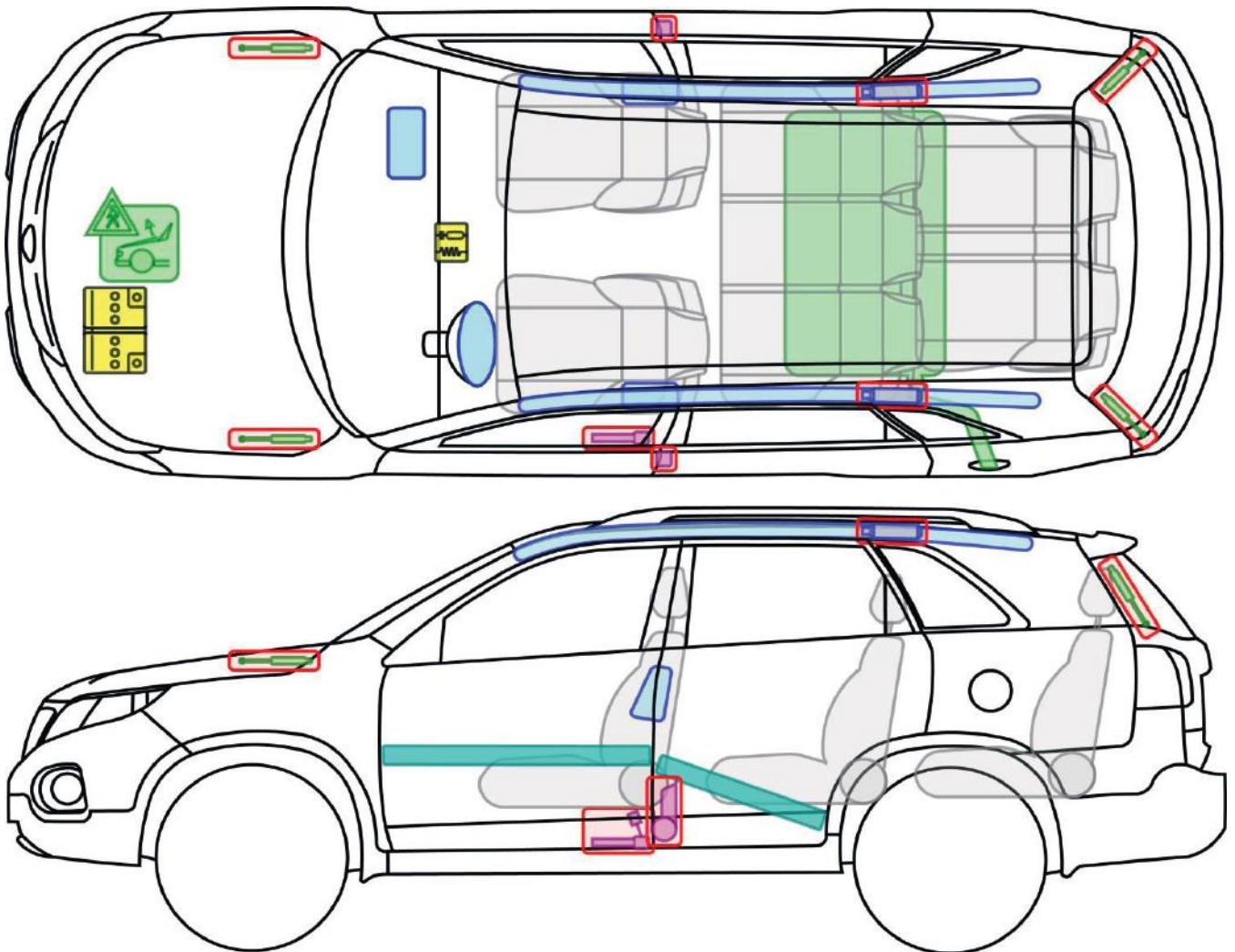

Legende

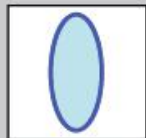

Airbag



Karosserie-
verstärkung



Steuergerät



Fußgänger-
schutz-
system

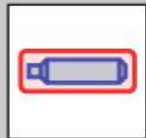

Gas-
generator



Überroll-
schutz

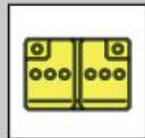

Batterie



Gurt-
straffer

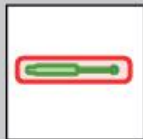

Gasdruck-
dämpfer



Kraftstoff-
tank

Sorento



Sorento (BL)

2006-2009

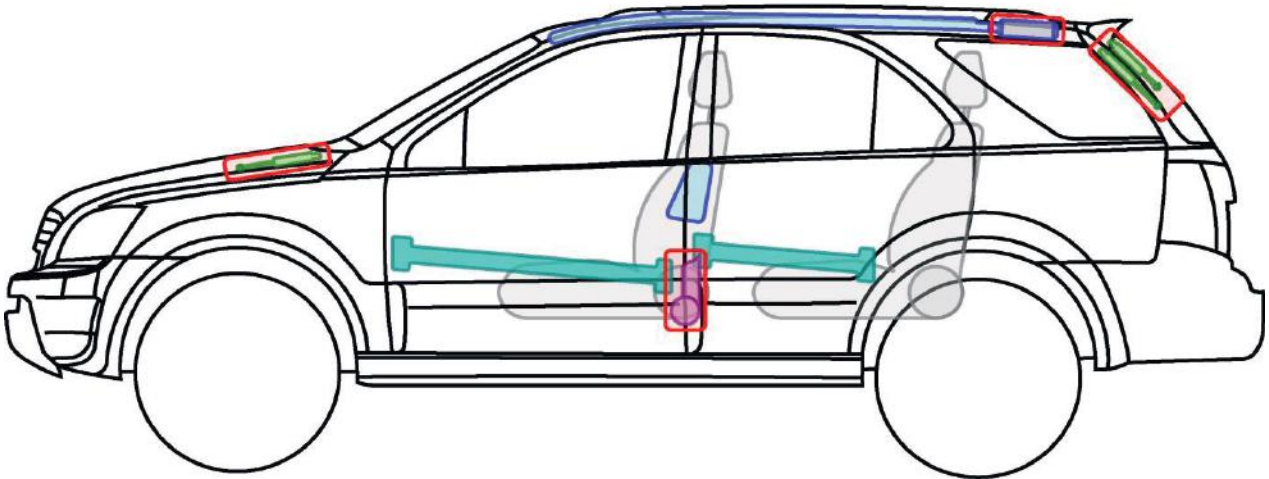
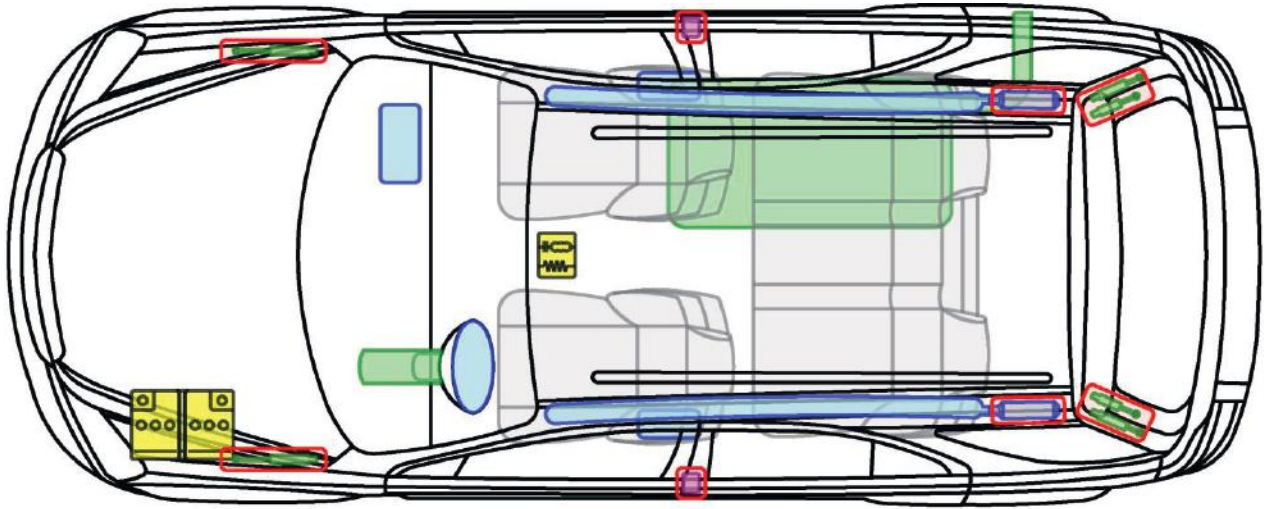

Legende

	Airbag		Karosserie-verstärkung		Steuergerät
	Gas-generator		Überroll-schutz		Batterie
	Gurt-straffer		Gasdruck-dämpfer		Kraftstoff-tank

Sorento



Sorento (BL)

2002-2006

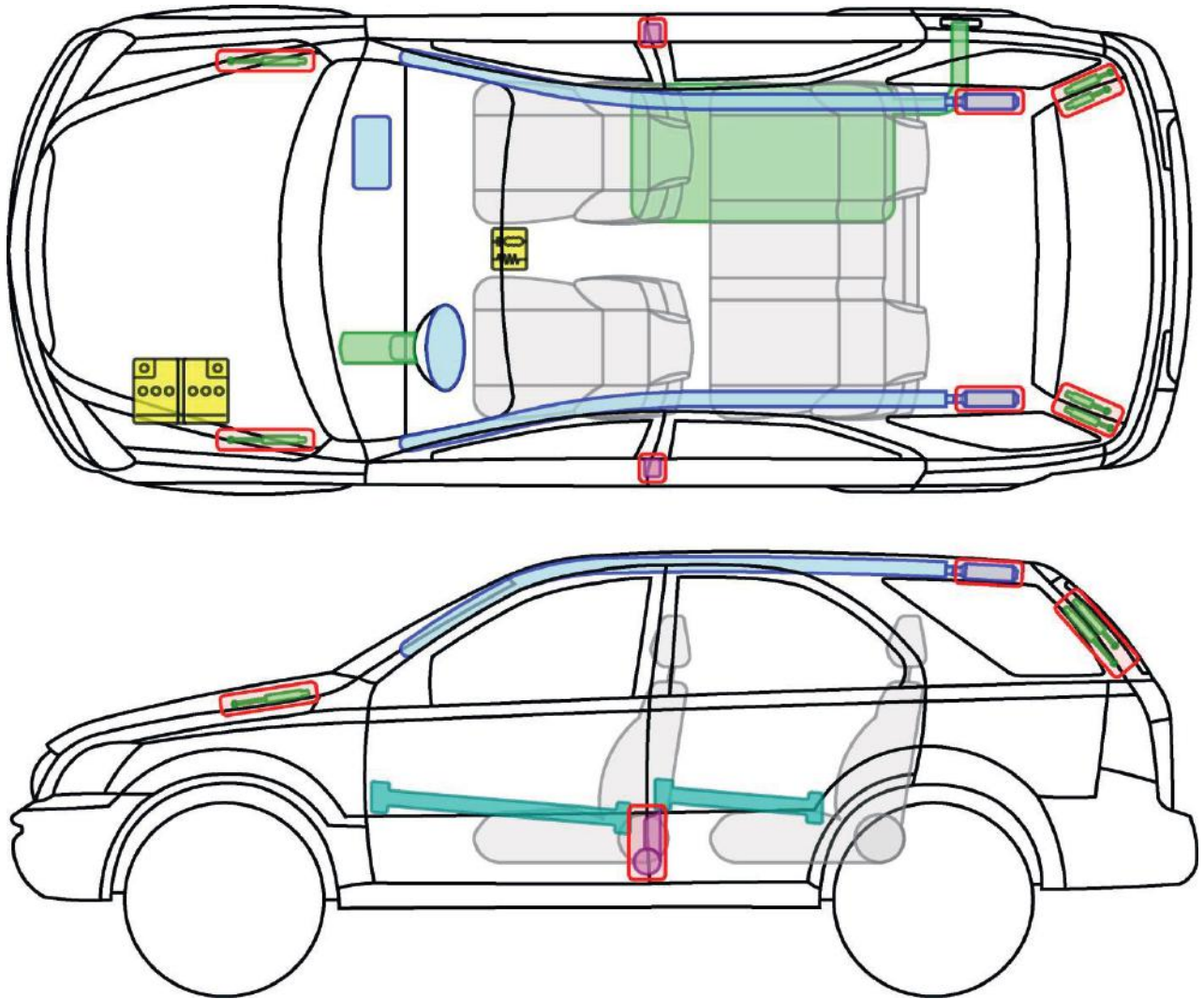

Legende

	Airbag		Karosserie- verstärkung		Steuergerät
	Gas- generator		Überroll- schutz		Batterie
	Gurt- straffer		Gasdruck- dämpfer		Kraftstoff- tank

Sorento



Rettungsdatenblätter

Diese Rettungsdatenblätter dienen ausschließlich Einsatzkräften auf dem Gebiet der technischen Hilfeleistung.

Alle auf den Rettungsdatenblättern enthaltenen Informationen sind ausschließlich für Fahrzeuge, welche für den europäischen Markt bestimmt sind. In den Rettungsdatenblättern ist immer die maximal mögliche Ausstattung der Fahrzeuge gezeigt.

Rechtsgelenkte Fahrzeuge können Bauart bedingt abweichen.

Fahrzeuge und Ausstattungsvarianten unterliegen ständigen Änderungen. KIA behält sich das Recht vor, Konstruktionen und Spezifikationen jederzeit ohne Ankündigung und ohne Übernahme eine Verpflichtung auslaufen zu lassen oder zu ändern.

Hinweis:

Diese Informationen sind ausschließlich für geschulte Einsatzkräfte und nicht für Endkunden, Werkstätten und Händler bestimmt.